

| REVISIONS | | |
|-----------|-----------------------|-----------------|
| SYM | DESCRIPTION | CHG BY |
| 01 | Printed August 1 2005 | JEFF L TJUNG |

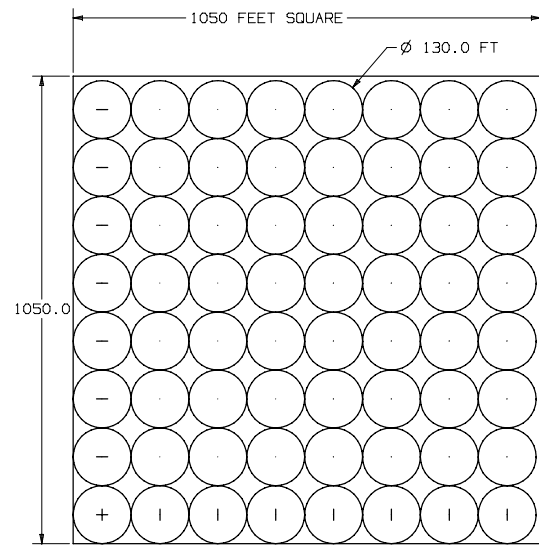
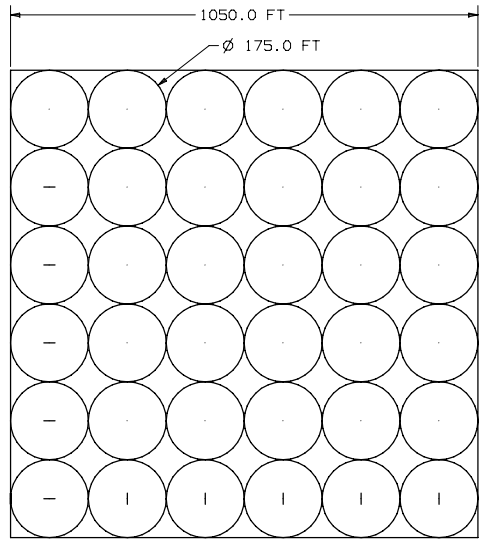

HARBOR SIMULATED MOORING CONDITIONS

1. STANDARD WATER DEPTH IS 10 FT.
2. STANDARD REQUIRED MOORING SCOPE IS 4 TO 1.
3. SWING CIRCLE WITH 4 TO 1 CHAIN TO MOORING BALL AND 15 FT PENDANT TO BOAT CLEAT IS 175 FT.
4. THIS EQUALS 36 BOATS IN A 1050FT SQUARE GRID.

5. SWING CIRCLE FOR HAZELETT ELASTIC MOORING EQUIPMENT AND A 15 FT PENDANT 130 FT.

6. THIS EQUALS 64 BOATS IN A 1050 FT SQUARE GRID.

THE BOAT SIZE FOR THIS "IDEA DESIGN" IS 34 FEET.

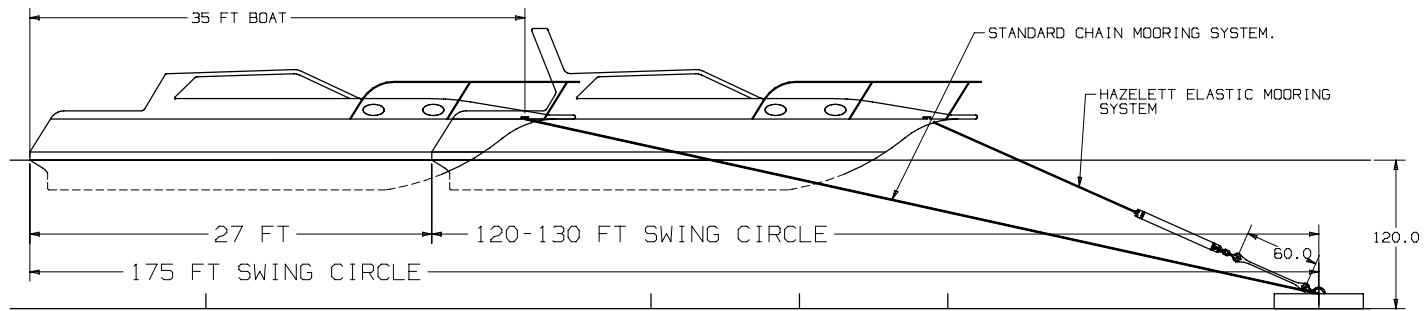

HYANNIS, MA HAS AVERAGE DEPTH OF 10 FT OF WATER AND REQUIRES 4 TO 1 SCOPE.

| | |
|--|--------------------|
| HAZELETT MARINE | |
| PO BOX 600 135 WEST LAKESHORE DRIVE WALLETT'S BAY, CHESTER, VT 05446 hazeletmarine.com | |
| DR: | JEFF L 1 AUG 05 |
| ENGR: | JEFF L |
| SCALE: | DO NOT SCALE |
| CUSTOMER: | HYANNIS YACHT CLUB |
| LOCATION: | HYANNIS MA |
| SITE: | |
| HAZELETT PRESENTATION SWING CIRCLE | |
| PART NO. | XXXX 01 |
| SHEET | 1 OF 4 |

| REVISIONS | | |
|-----------|---------------------|------------------|
| SYM | DESCRIPTION | CHG BY |
| 01 | PRINTED 1 JUNE 2005 | JEFF L TJUNG5 |

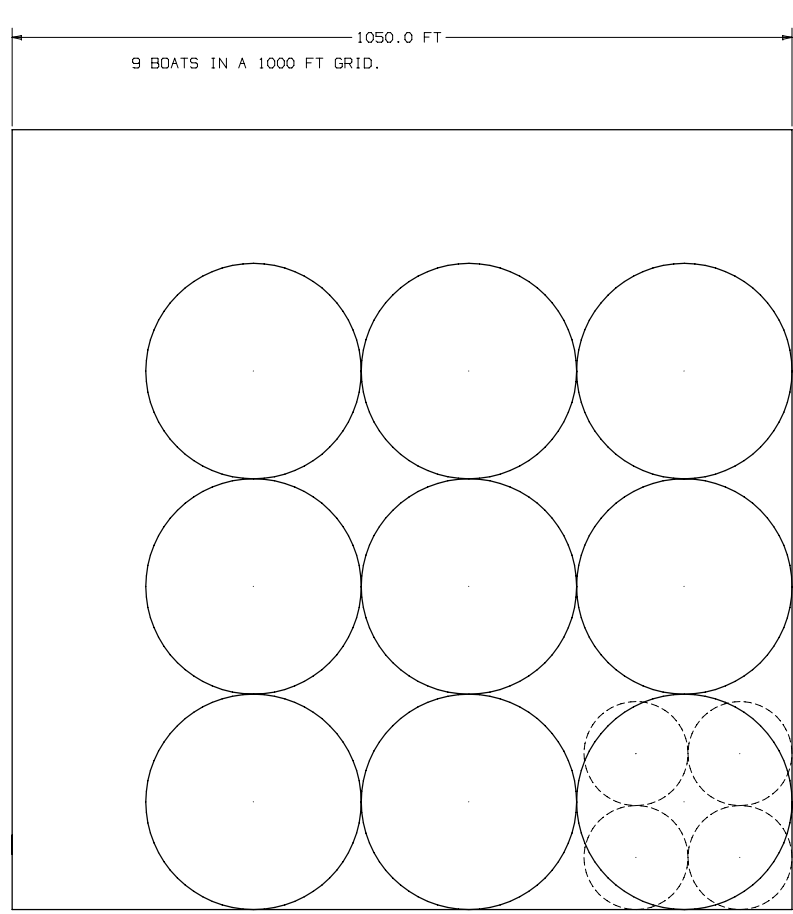

HARBOR SIMULATED MOORING CONDITIONS

1. STANDARD WATER DEPTH IS 25 FT.
2. STANDARD REQUIRED MOORING SCOPE IS 4 TO 1.
3. SWING CIRCLE WITH 4 TO 1 CHAIN TO MOORING BALL AND 15 FT PENDANT TO BOAT CLEAT IS 290 FT.
4. THIS EQUALS 36 BOATS IN A 1050FT SQUARE GRID.

THE BOAT SIZE FOR THIS "IDEA DESIGN" IS 34 FEET.

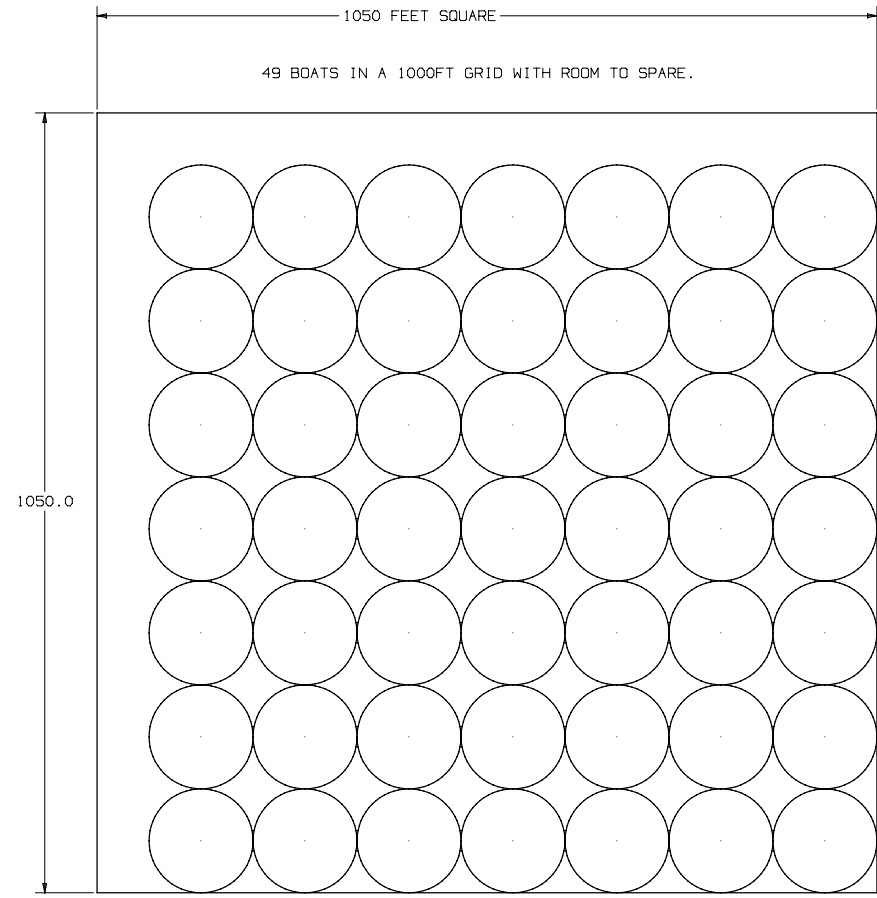

5. SWING CIRCLE FOR HAZELETT ELASTIC MOORING EQUIPMENT AND A 15 FT PENDANT 142 FT.

6. THIS EQUALS 49 BOATS IN A 1050 FT SQUARE GRID.

| | | | |
|---|--------------------|-----------|---------|
| HAZELETT MARINE | | | |
| PO BOX 800 136 WEST LAKESHORE DRIVE MILLETTS BAY, GILCHESTER, VT 05446 hazelettmarine.com | | | |
| DR: | JEFF L | 1 JUNE 05 | |
| ENG: | JEFF L | | |
| SCALE: | DO NOT SCALE | | |
| CUSTOMER: | NEWPORT YACHT CLUB | | |
| LOCATION: | HYANNIS MA | PART NO. | XXXX 01 |
| LOCATION: | SITE | SHEET | 2 OF 2 |

XXXXXX

HMS-ANCHORING.CAD

1 D-SIZE

| REVISIONS | | |
|-----------|---------------------|---------------|
| SYM | DESCRIPTION | CHG BY |
| 01 | PRINTED 1 JUNE 2005 | JEFF L TJUNG5 |

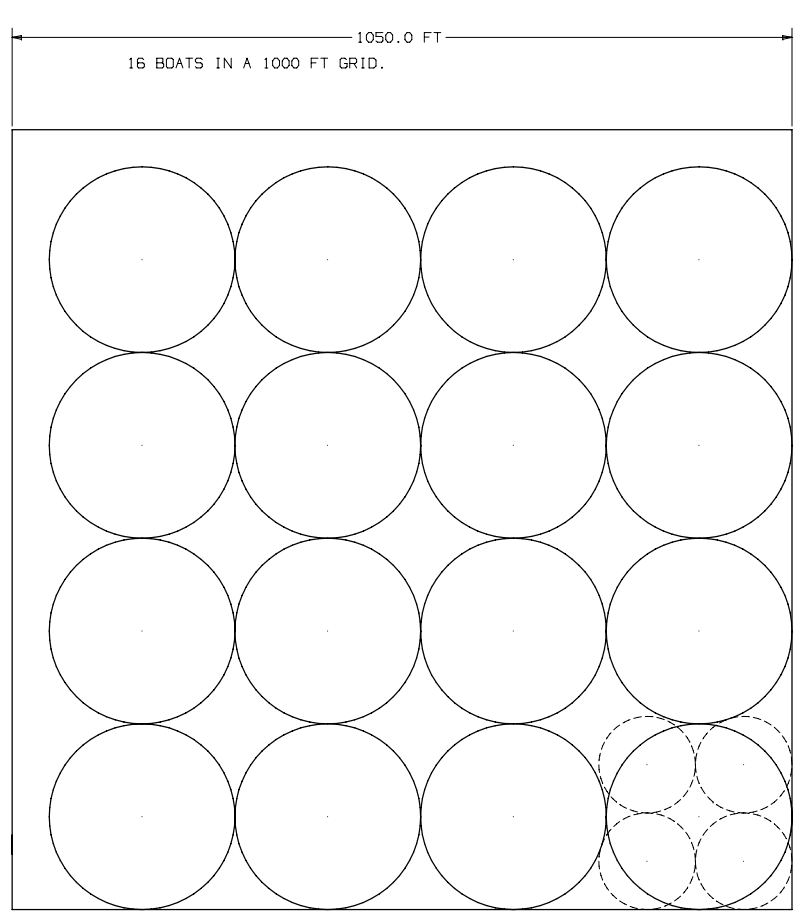

HARBOR SIMULATED MOORING CONDITIONS

1. STANDARD WATER DEPTH IS 20 FT.
2. STANDARD REQUIRED MOORING SCOPE IS 4 TO 1.
3. SWING CIRCLE WITH 4 TO 1 CHAIN TO MOORING BALL AND 15 FT PENDANT TO BOAT CLEAT IS 250 FT.
4. THIS EQUALS 36 BOATS IN A 1050FT SQUARE GRID.

THE BOAT SIZE FOR THIS "IDEA DESIGN" IS 34 FEET.

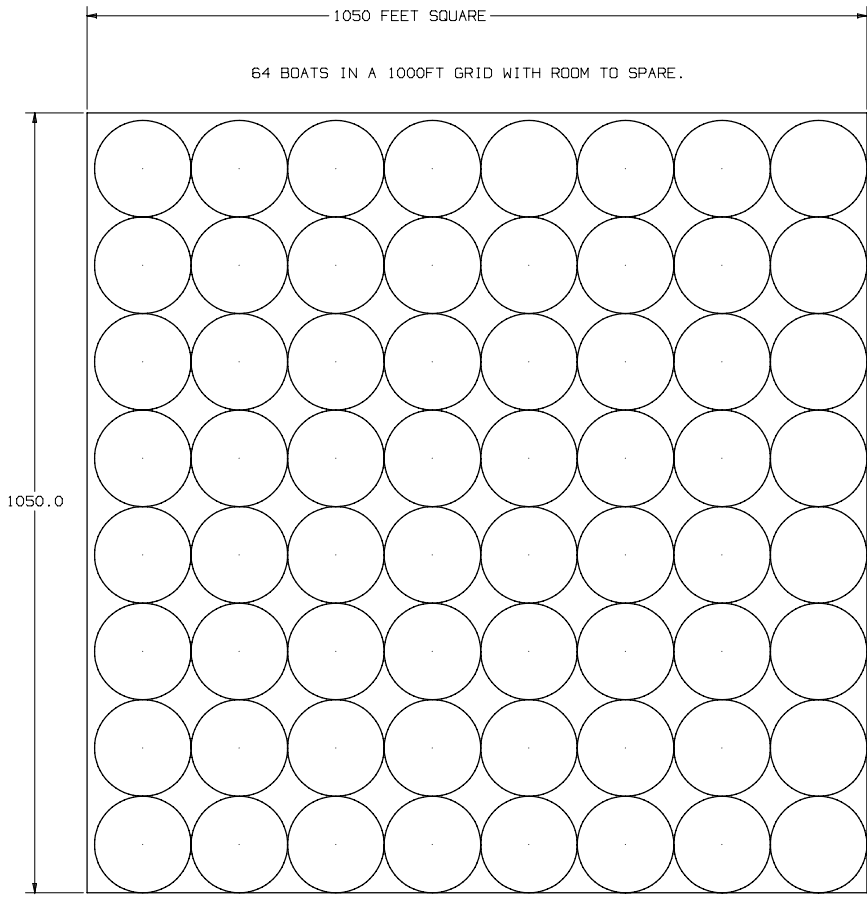

5. SWING CIRCLE FOR HAZELETT ELASTIC MOORING EQUIPMENT AND A 15 FT PENDANT 130 FT.

6. THIS EQUALS 64 BOATS IN A 1050 FT SQUARE GRID.

| | | | |
|--|--------------------|---|--|
| HAZELETT MARINE | |  | |
| PO BOX 800 136 WEST LAKESHORE DRIVE HALLETT'S BAY, GILCHESTER, VT 05448 hazelettmarine.com | | | |
| DR: | JEFF L 1 JUNE 05 | HAZELETT PRESENTATION SWING CIRCLE | |
| DR: | JEFF L | PART NO. XXXX 01 | |
| ENG: | JEFF L | SHEET 2 OF 2 | |
| SCALE: | DO NOT SCALE | | |
| CUSTOMER: | NEWPORT YACHT CLUB | | |
| LOCATION: | HYANNIS MA | | |
| LOCATION: | SITE | | |

| REVISIONS | | |
|-----------|---------------------|---------------|
| SYM | DESCRIPTION | CHG BY |
| 01 | PRINTED 1 JUNE 2005 | JEFF L TJUNG5 |

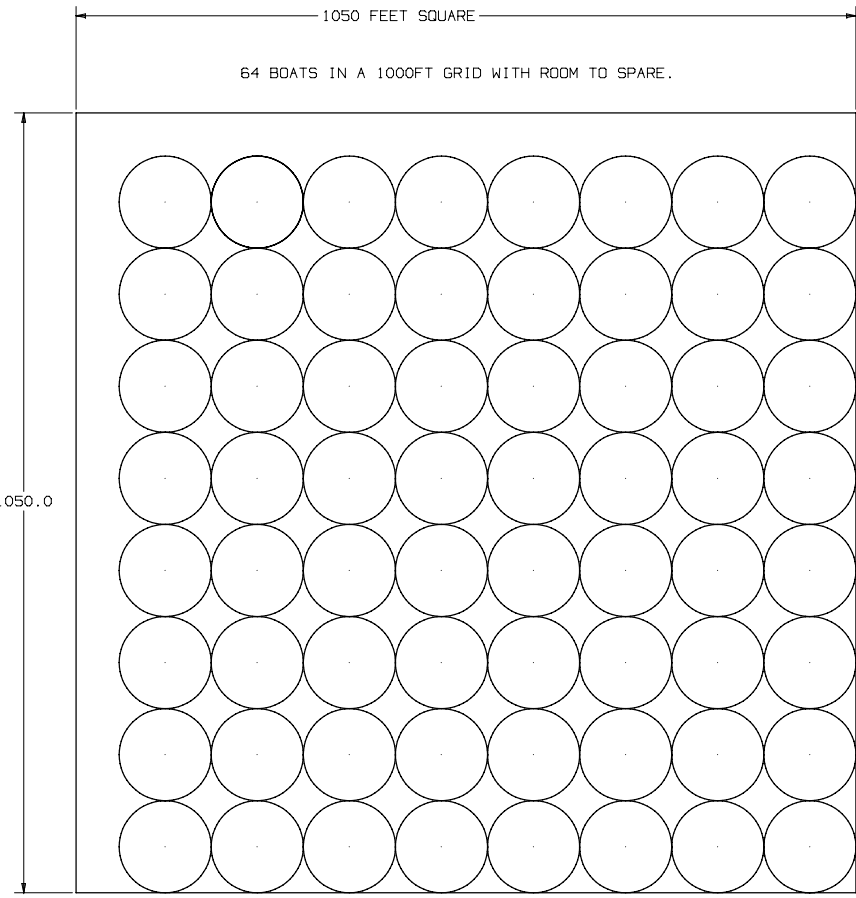
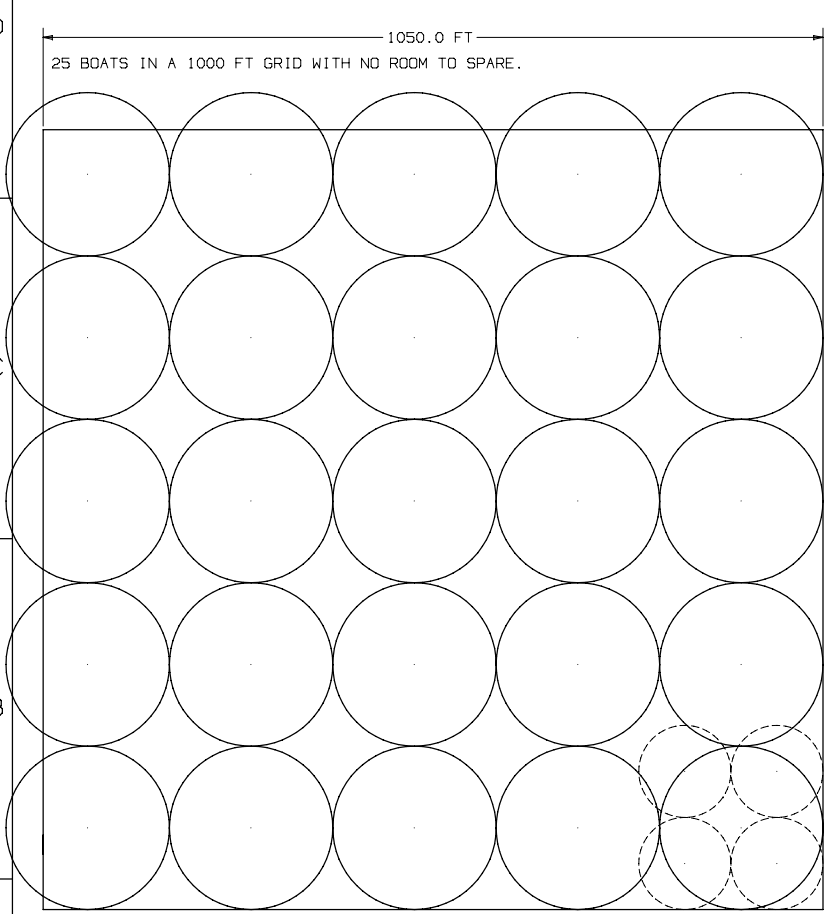

1. STANDARD WATER DEPTH IS 15 FT.
2. STANDARD REQUIRED MOORING SCOPE IS 4 TO 1.
3. SWING CIRCLE WITH 4 TO 1 CHAIN TO MOORING BALL AND 15 FT PENDANT TO BOAT CLEAT IS 220 FT.
4. THIS EQUALS 36 BOATS IN A 1050FT SQUARE GRID.

5. SWING CIRCLE FOR HAZELETT ELASTIC MOORING EQUIPMENT AND A 15 FT PENDANT 124 FT.
6. THIS EQUALS 64 BOATS IN A 1050 FT SQUARE GRID.

THE BOAT SIZE FOR THIS "IDEA DESIGN" IS 34 FEET.

| | | | |
|--|--------------------|---|---------|
| HAZELETT MARINE | |  | |
| PO BOX 800 136 WEST LAKESHORE DRIVE HALLETTS BAY, GILCHESTER, VT 05446 hazellettmarine.com | | | |
| DR: | JEFF L JUNE 05 | HAZELETT PRESENTATION SWING CIRCLE | |
| ENG: | JEFF L | PART NO. | XXXX 01 |
| SCALE: | DO NOT SCALE | SHEET | 2 OF 2 |
| CUSTOMER: | NEWPORT YACHT CLUB | | |
| LOCATION: | HYANNIS MA | | |
| SITE: | | | |

| REVISIONS | | |
|-----------|---------------------|------------------|
| SYM | DESCRIPTION | CHG BY |
| 01 | PRINTED 1 JUNE 2005 | JEFF L TUANGS |

25 BOATS IN A TRADITIONAL MOORING GRID.

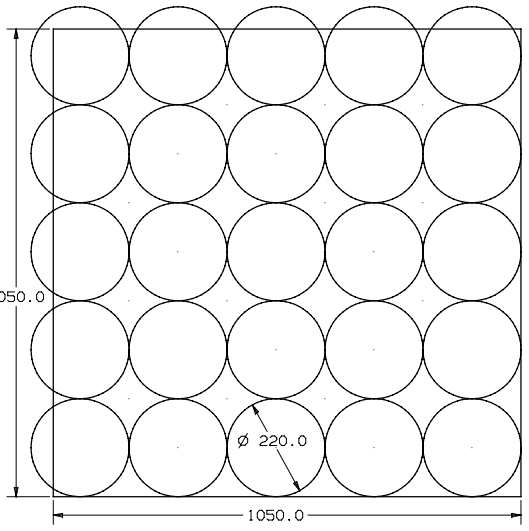

64 BOATS IN A HHAZELETT MARINE ELASTIC MOORING GRID

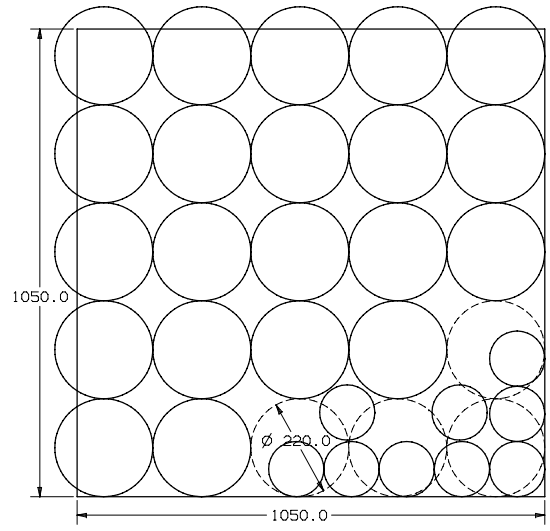
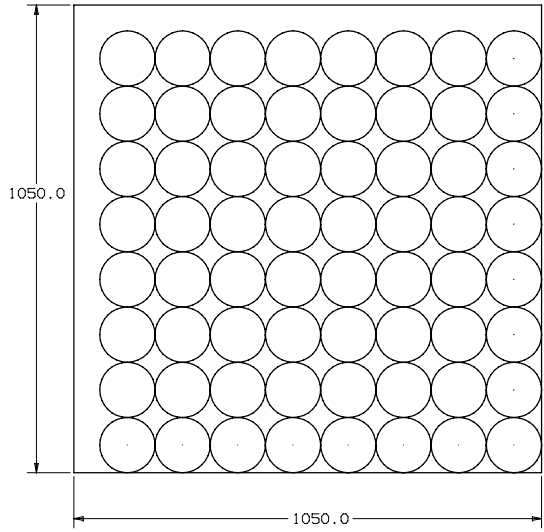

FOUR BOATS CONVERT TO THE SHORT SCOPE HAZELETT ELASTIC MOORING SYSTEM AND THIS MAKES ROOM FOR NINE BOATS.

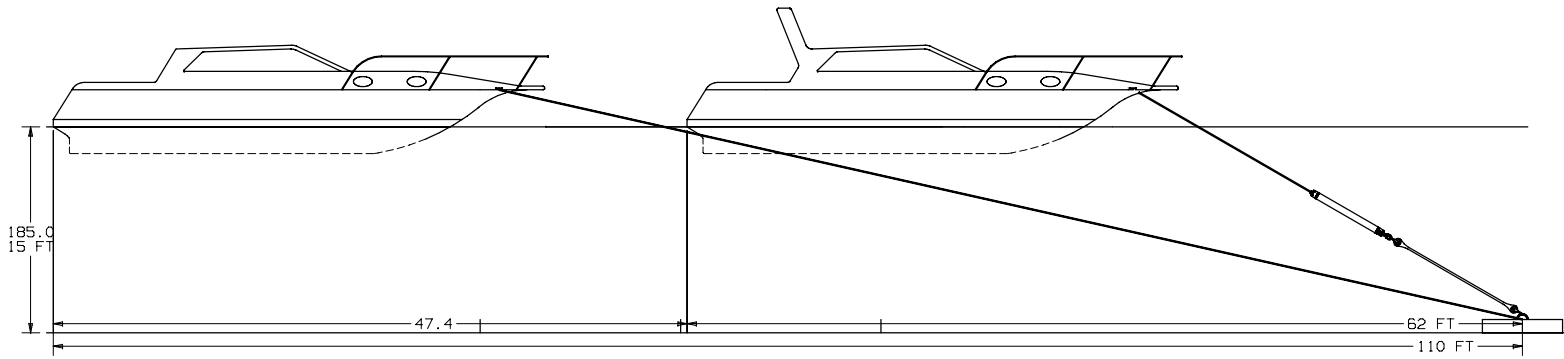

HAZELETT MARINE
 PO BOX 800 135 WEST LAKESHORE DRIVE
 HALLETTS BAY, COLCHESTER, VT 05448
 hazelettmarine.com

DR: JEFF L 1 JUNE 05
 ENG: JEFF L
 SCALE: DO NOT SCALE
 CUSTOMER: HYANNIS YACHT CLUB
 LOCATION: HYANNIS MA
 SITE

HAZELETT PRESENTATION SWING CIRCLE
 PART NO. XXXX 01
 SHEET 1 OF 2